

Features

- 900 nA Maximum Supply Current
- Ultra-low Single-Supply Operation Down to +1.8V
- Ground-Sensing Input Common-Mode Range
- Outputs Swing Rail-to-Rail
- Offset Voltage: 0.6 mV Maximum
- Ultra-low V_{OS} TC: 0.4 $\mu\text{V}/^\circ\text{C}$
- Ultra-low Input Bias Current: 1 fA Typical
- Stable 18 kHz GBWP with 10 mV/ μs Slew Rate
- High 120 dB Open-Loop Voltage Gain
- Unity Gain Stable
- Outputs Source and Sink 20mA of Load Current
- No Phase Reversal for Overdriven Inputs
- Shutdown Pin Feature (TP2191N)
- -40°C to 125°C Operation Range
- Robust 8kV – HBM and 2kV – CDM ESD Rating
- Green, SC70/SOT23 Small Size Package

Applications

- Current Sensing
- Threshold Detectors/Discriminators
- Low Power Filters
- Wireless Remote Sensors, Active RFID Readers
- Environment/Gas/Oxygen Sensors
- Handsets and Mobile Accessories
- Battery or Solar Powered Devices
- Sensor Network Powered by Energy Scavenging

Description

The TP2191(N) is a precision, ultra-low power CMOS op-amp featuring a maximum supply current of 900 nA with an ultra-low typical input bias current of 1 fA. Analog trim and calibration routine reduce input offset voltage to below 600 μV , and the precision temperature compensation technique makes offset voltage temperature drift at 0.4 $\mu\text{V}/^\circ\text{C}$, which allowing use of the TP2191(N) in systems with high gain without creating excessively large output offset errors.

The TP2191(N) is unity gain stable with a constant 18 kHz GBWP, 10 mV/ μs slew rate, which make them appropriate for low frequency applications, such as battery current monitoring and sensor conditioning. The TP2191(N) can operate from a single-supply voltage of +1.8V to +6.0V or a dual-supply voltage of $\pm 0.9\text{V}$ to $\pm 3.0\text{V}$. Beyond the rails input makes it very prominent in low voltage (< 3V) rail-to-rail input applications.

The combined features make the TP2191(N) an ideal choice for battery-powered applications because it minimize errors due to power supply voltage variations over the lifetime of the battery and maintain high CMRR even for a rail-to-rail input op-amp. Mobile accessories, wireless remote sensing, backup battery sensors, and single-Li+ or 2-cell NiCd/Alkaline battery powered systems can benefit from the features of the TP2191(N) op-amp.

3PEAK and the 3PEAK logo are registered trademarks of 3PEAK INCORPORATED. All other trademarks are the property of their respective owners.

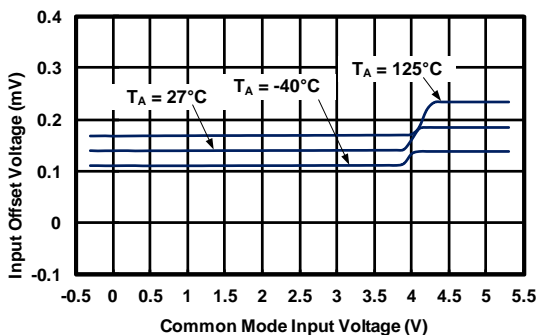

Ground-Sensing Input Common-Mode Range

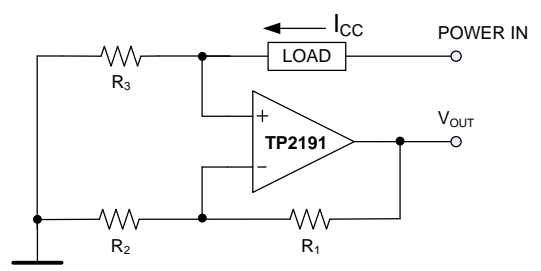
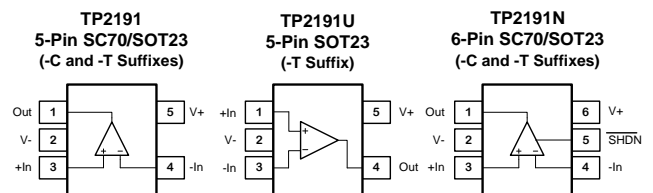

$$V_{OUT} = I_{CC} \times R_3 \times \left(\frac{R_1}{R_2} + 1 \right)$$

TP2191 in Low Side Battery Current Sensor

TP2191/TP2191N

Small Size, Precision, 1.8V, 700nA Nanopower, RRIO Op-amps

Order Information

Model Name	Order Number	Package	Transport Media, Quantity	Marking Information
TP2191	TP2191-CR	5-Pin SC70	Tape and Reel, 3,000	B2CYW ⁽¹⁾
	TP2191-TR	5-Pin SOT23	Tape and Reel, 3,000	B2TYW ⁽¹⁾
TP2191U	TP2191U-TR	5-Pin SOT23	Tape and Reel, 3,000	BU2YW ⁽¹⁾
TP2191N	TP2191N-CR	6-Pin SC70	Tape and Reel, 3,000	B2MYW ⁽¹⁾
	TP2191N-TR	6-Pin SOT23	Tape and Reel, 3,000	B2NYW ⁽¹⁾

Note (1): 'YW' is date coding scheme. 'Y' stands for calendar year, and 'W' stands for single workweek coding scheme.

Absolute Maximum Ratings ^{Note 1}

Supply Voltage: $V^+ - V^-$ 6.0V
Input Voltage..... $V^- - 0.3$ to $V^+ + 0.3$
Input Current: +IN, -IN, SHDN ^{Note 2} ± 10 mA
SHDN Pin Voltage..... V^- to V^+
Output Current: OUT..... ± 20 mA

Output Short-Circuit Duration ^{Note 3} Indefinite
Operating Temperature Range..... -40°C to 125°C
Maximum Junction Temperature..... 150°C
Storage Temperature Range..... -65°C to 150°C
Lead Temperature (Soldering, 10 sec) 260°C

Note 1: Stresses beyond those listed under Absolute Maximum Ratings may cause permanent damage to the device. Exposure to any Absolute Maximum Rating condition for extended periods may affect device reliability and lifetime.

Note 2: The inputs are protected by ESD protection diodes to each power supply. If the input extends more than 500mV beyond the power supply, the input current should be limited to less than 10mA.

Note 3: A heat sink may be required to keep the junction temperature below the absolute maximum. This depends on the power supply voltage and how many amplifiers are shorted. Thermal resistance varies with the amount of PC board metal connected to the package. The specified values are for short traces connected to the leads.

ESD, Electrostatic Discharge Protection

Symbol	Parameter	Condition	Minimum Level	Unit
HBM	Human Body Model ESD	MIL-STD-883H Method 3015.8	8	kV
CDM	Charged Device Model ESD	JEDEC-EIA/JESD22-C101E	2	kV

5V Electrical Characteristics

The ● denotes the specifications which apply over the full operating temperature range, otherwise specifications are at $T_A = 27^\circ\text{C}$. $V_{\text{SUPPLY}} = 5\text{V}$, $V_{\text{CM}} = V_{\text{OUT}} = V_{\text{SUPPLY}}/2$, $R_L = 100\text{k}\Omega$, $C_L = 60\text{pF}$, V_{SHDN} is unconnected.

SYMBOL	PARAMETER	CONDITIONS	MIN	TYP	MAX	UNITS
V_{OS}	Input Offset Voltage	$V_{\text{CM}} = V_{\text{DD}}/2$	-0.6	± 0.1	+0.6	mV
$V_{\text{OS TC}}$	Input Offset Voltage Drift			0.4		$\mu\text{V}/^\circ\text{C}$
I_{B}	Input Bias Current	$T_A = 27^\circ\text{C}$		1		fA
		$T_A = 85^\circ\text{C}$		500		fA
		$T_A = 125^\circ\text{C}$		40		pA
I_{OS}	Input Offset Current		1		fA	
V_{n}	Input Voltage Noise	$f = 0.1\text{Hz to } 10\text{Hz}$		6.5		$\mu\text{V}_{\text{P-P}}$
e_{n}	Input Voltage Noise Density	$f = 1\text{kHz}$		170		$\text{nV}/\sqrt{\text{Hz}}$
R_{IN}	Input Resistance			> 1		$\text{T}\Omega$
C_{IN}	Input Capacitance	Differential		2.9		pF
		Common Mode		5		
CMRR	Common Mode Rejection Ratio	$V_{\text{CM}} = 0.1\text{V to } 4.9\text{V}$	●	80	130	dB
V_{CM}	Common-mode Input Voltage Range		●	$V^- - 0.3$	$V^+ + 0.3$	V
PSRR	Power Supply Rejection Ratio		●	60	92	dB
A_{VOL}	Open-Loop Large Signal Gain	$V_{\text{OUT}} = 2.5\text{V}$, $R_{\text{LOAD}} = 100\text{k}\Omega$	●	80	120	dB
		$V_{\text{OUT}} = 0.1\text{V to } 4.9\text{V}$, $R_{\text{LOAD}} = 100\text{k}\Omega$	●	80	120	dB
$V_{\text{OL}}, V_{\text{OH}}$	Output Swing from Supply Rail	$R_{\text{LOAD}} = 100\text{k}\Omega$		5		mV
R_{OUT}	Closed-Loop Output Impedance	$G = 1$, $f = 1\text{kHz}$, $I_{\text{OUT}} = 0$		0.4		Ω
R_{O}	Open-Loop Output Impedance	$f = 1\text{kHz}$, $I_{\text{OUT}} = 0$		2.6		Ω
I_{SC}	Output Short-Circuit Current	Sink or source current		20		mA
V_{DD}	Supply Voltage		1.8		6.0	V
I_{Q}	Quiescent Current		●	700	900	nA
PM	Phase Margin	$R_{\text{LOAD}} = 100\text{k}\Omega$, $C_{\text{LOAD}} = 60\text{pF}$		61		$^\circ$
GM	Gain Margin	$R_{\text{LOAD}} = 100\text{k}\Omega$, $C_{\text{LOAD}} = 60\text{pF}$		-10		dB
GBWP	Gain-Bandwidth Product	$f = 1\text{kHz}$		18		kHz
t_{s}	Settling Time, 1.5V to 3.5V, Unity Gain	0.1%		0.25		ms
		0.01%		0.253		
	Settling Time, 2.45V to 2.55V, Unity Gain	0.1%		0.035		
		0.01%		0.038		
SR	Slew Rate	$A_{\text{V}} = 1$, $V_{\text{OUT}} = 1.5\text{V to } 3.5\text{V}$, $C_{\text{LOAD}} = 60\text{pF}$, $R_{\text{LOAD}} = 100\text{k}\Omega$		10		$\text{mV}/\mu\text{s}$
FPBW	Full Power Bandwidth ^{Note 2}	$2V_{\text{P-P}}$		600		Hz
$I_{\text{Q(off)}}$	Supply Current in Shutdown ^{Note 1}			3		nA
I_{SHDN}	Shutdown Pin Current ^{Note 1}	$V_{\text{SHDN}} = 0.5\text{V}$		-10		pA
		$V_{\text{SHDN}} = 1.5\text{V}$		-10		
I_{LEAK}	Output Leakage Current in Shutdown ^{Note 1}	$V_{\text{SHDN}} = 0\text{V}$, $V_{\text{OUT}} = 0\text{V}$		-3.6		pA
		$V_{\text{SHDN}} = 0\text{V}$, $V_{\text{OUT}} = 5\text{V}$		3.6		
V_{IL}	SHDN Input Low Voltage ^{Note 1}	Disable	●		0.5	V
V_{IH}	SHDN Input High Voltage ^{Note 1}	Enable	●	1.0		V

Note 1: Specifications apply to the TP2191N with shutdown.

Note 2: Full power bandwidth is calculated from the slew rate $\text{FPBW} = \text{SR}/\pi \cdot V_{\text{P-P}}$.

TP2191/TP2191N

Small Size, Precision, 1.8V, 700nA Nanopower, RRIO Op-amps

Typical Performance Characteristics

Small-Signal Step Response, 100mV Step

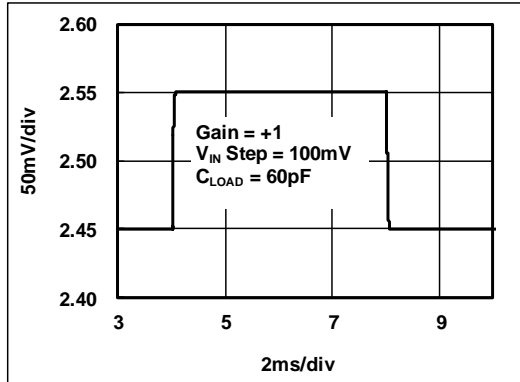

Large-Signal Step Response, 2V Step

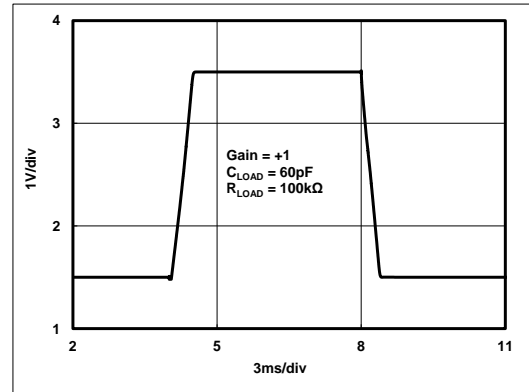

Open-Loop Gain and Phase

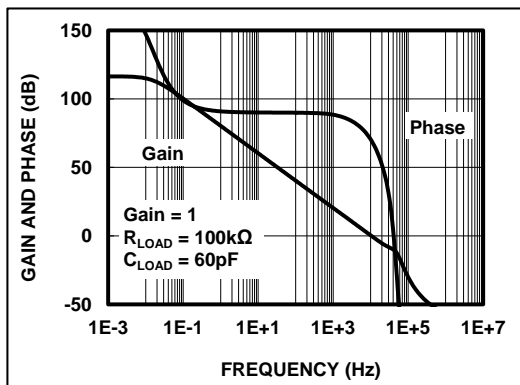

Phase Margin vs. C_{LOAD} (Stable for Any C_{LOAD})

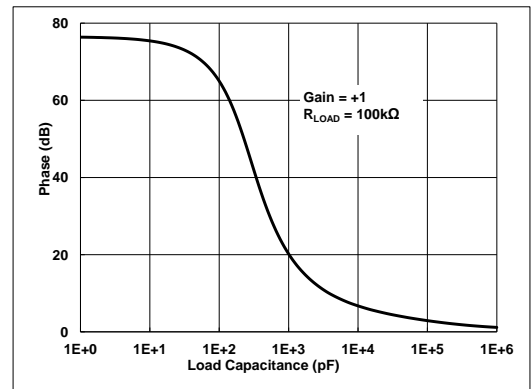

Input Voltage Noise Spectral Density

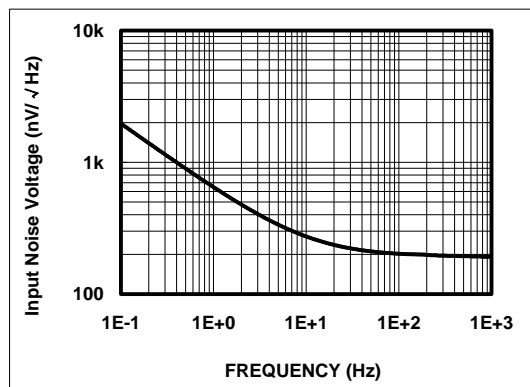

CMRR and PSRR

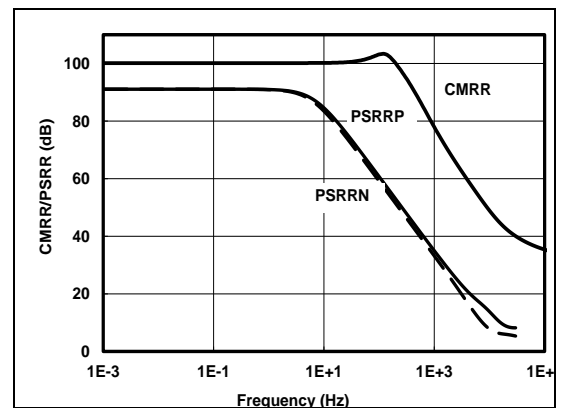

Typical Performance Characteristics

Over-Shoot Voltage, $C_{LOAD} = 40nF$, Gain = +1, $R_{FB}=100k\Omega$

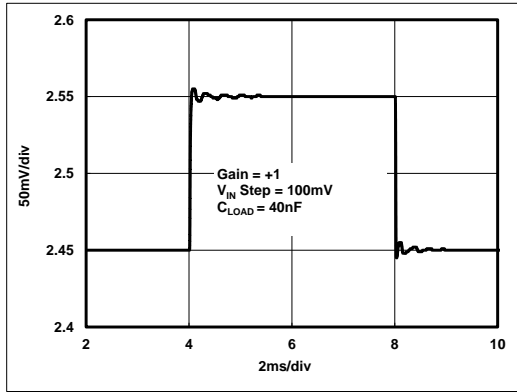

Over-Shoot % vs. C_{LOAD} , Gain = +1, $R_{FB} = 1M\Omega$

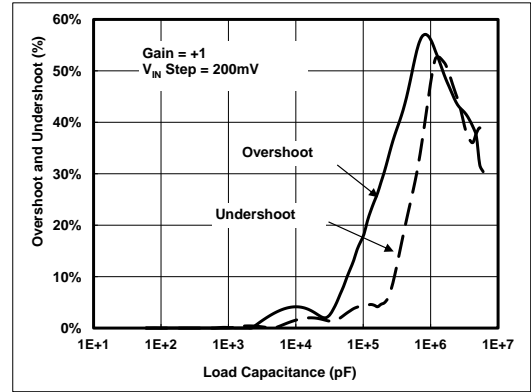

Over-Shoot Voltage, $C_{LOAD}=40nF$, Gain = -1, $R_{FB}=100k\Omega$

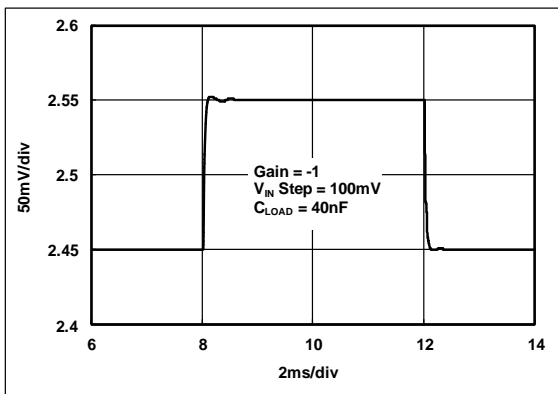

Over-Shoot % vs. C_{LOAD} , Gain = -1, $R_{FB} = 1M\Omega$

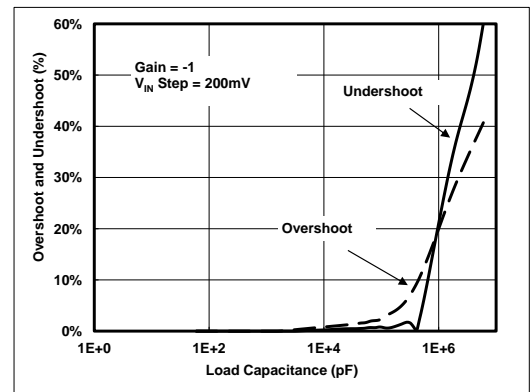

Closed-Loop Output Impedance vs. Frequency

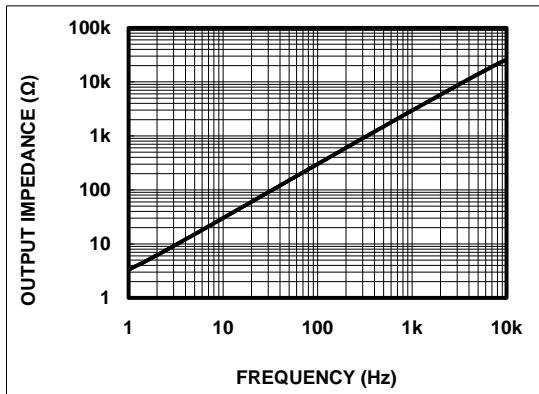

$V_{IN} = -0.2V$ to $5.7V$, No Phase Reversal

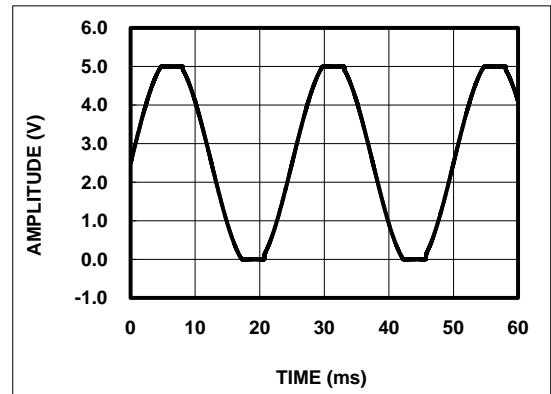

TP2191/TP2191N

Small Size, Precision, 1.8V, 700nA Nanopower, RRIO Op-amps

Typical Performance Characteristics

Quiescent Supply Current vs. Temperature

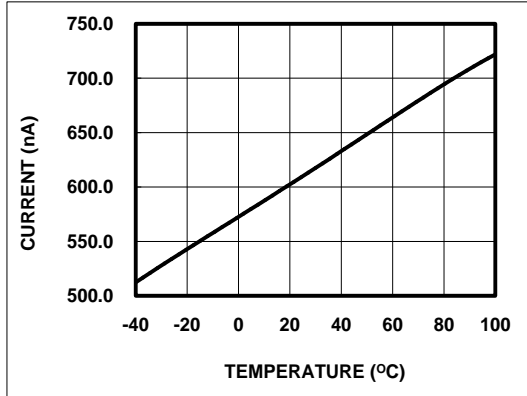

Open-Loop Gain vs. Temperature

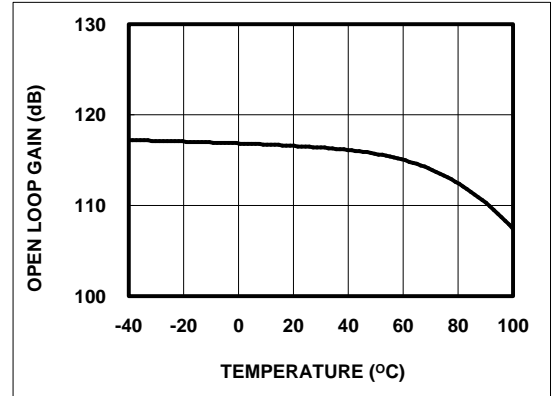

Quiescent Supply Current vs. Supply Voltage

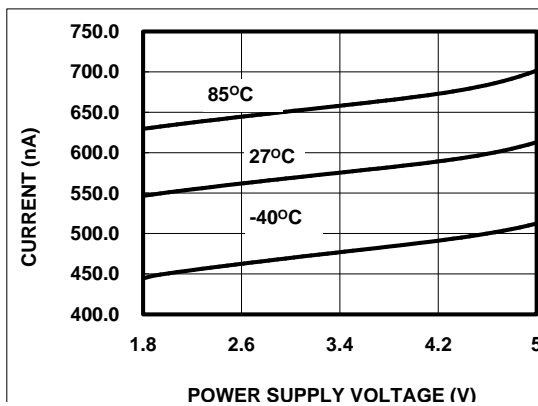

Short-Circuit Current vs. Supply Voltage

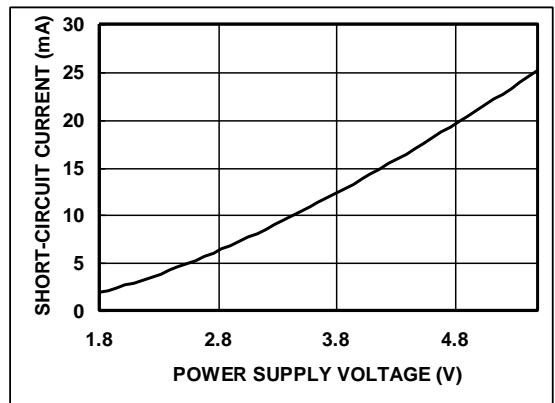

Input Offset Voltage Distribution

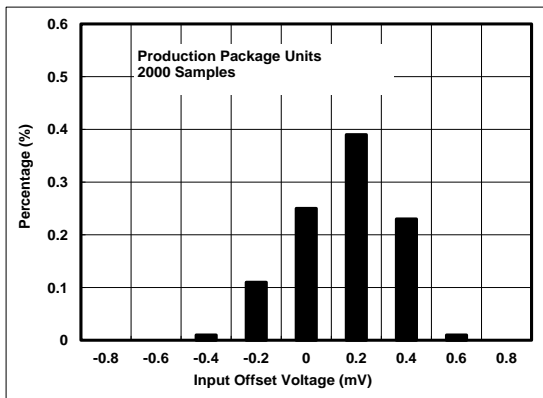

0.1Hz to 10Hz Time Domain Output Voltage Noise

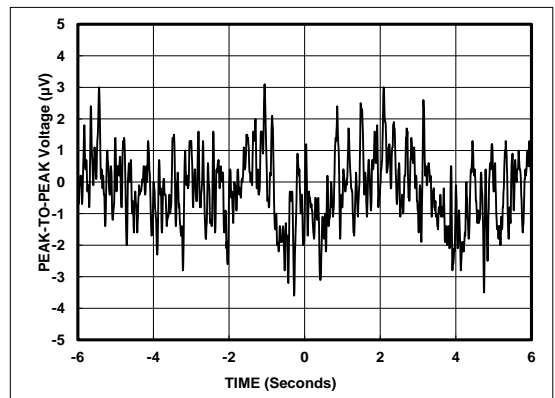

Pin Functions

-IN: Inverting Input of the Amplifier. Voltage range of this pin can go from $V^- - 0.3V$ to $V^+ + 0.3V$.

+IN: Non-Inverting Input of Amplifier. This pin has the same voltage range as -IN.

V+ or +V_S: Positive Power Supply. Typically the voltage is from 1.8V to 5.5V. Split supplies are possible as long as the voltage between V+ and V- is between 1.8V and 5.5V. A bypass capacitor of 0.1 μF as close to the part as possible should be used between power supply pins or between supply pins and ground.

V- or -V_S: Negative Power Supply. It is normally tied to ground. It can also be tied to a voltage other than ground as long as the voltage between V^+ and V^- is from 1.8V to 5.5V. If it is not connected to ground, bypass it with a capacitor of 0.1 μF as close to the part as possible.

SHDN: Active **Low** Shutdown. Shutdown threshold is **1.0V** above negative supply rail. If unconnected, the amplifier is automatically enabled.

OUT: Amplifier Output. The voltage range extends to within milli-volts of each supply rail.

Operation

The TP2191(N) input signal range extends beyond the negative and positive power supplies. The output can even extend all the way to the negative supply. The input stage is comprised of two CMOS differential amplifiers, a PMOS stage and NMOS stage that are active over different ranges of common mode input

voltage. The Class-AB control buffer and output bias stage uses a proprietary compensation technique to take full advantage of the process technology to drive very high capacitive loads. This is evident from the transient over shoot measurement plots in the Typical Performance Characteristics.

Applications Information

Low Supply Voltage and Low Power Consumption

The TP2191(N) of operational amplifier can operate with power supply voltages from 1.8V to 6.0V. Each amplifier draws only 700 nA quiescent current. The low supply voltage capability and low supply current are ideal for portable applications demanding HIGH CAPACITIVE LOAD DRIVING CAPABILITY and CONSTANT WIDE BANDWIDTH. The TP2191(N) is optimized for industrial precision and wide bandwidth low power applications. They have an industry leading high GBWP to power ratio and are unity gain stable for 1,000 nF capacitive load. When the load capacitance increases, the increased capacitance at the output pushed the non-dominant pole to lower frequency in the open loop frequency response, lowering the phase and gain margin. Higher gain configurations tend to have better capacitive drive capability than lower gain configurations due to lower closed loop bandwidth and hence higher phase margin.

Low Input Referred Noise

The TP2191(N) provides a low input referred noise density of 170 nV/ $\sqrt{\text{Hz}}$ at 1 kHz. The voltage noise will grow slowly with the frequency in wideband range, and the input voltage noise is typically 6.5 μV_{P-P} at the frequency of 0.1 Hz to 10 Hz.

Low Input Offset Voltage

The TP2191(N) has a low offset voltage of 600 μV maximum which is essential for precision applications. The offset voltage is trimmed with a proprietary trim algorithm to ensure low offset voltage for precision signal processing requirement.

TP2191/TP2191N

Small Size, Precision, 1.8V, 700nA Nanopower, RRIO Op-amps

Low Input Bias Current

The TP2191(N) is a CMOS op-amp family and features very low input bias current in pA range. The low input bias current allows the amplifier to be used in applications with high resistance sources. Care must be taken to minimize PCB Surface Leakage. See below section on “PCB Surface Leakage” for more details.

PCB Surface Leakage

In applications where low input bias current is critical, Printed Circuit Board (PCB) surface leakage effects need to be considered. Surface leakage is caused by humidity, dust or other contamination on the board. Under low humidity conditions, a typical resistance between nearby traces is $10^{12} \Omega$. A 5V difference would cause 5 pA of current to flow, which is greater than the TP2191(N) input bias current at +27 °C (± 1 pA, typical). It is recommended to use multi-layer PCB layout and route the OPA's -IN and +IN signal under the PCB surface.

The effective way to reduce surface leakage is to use a guard ring around sensitive pins (or traces). The guard ring is biased at the same voltage as the sensitive pin. An example of this type of layout is shown in Figure 1 for Inverting Gain application.

1. For Non-Inverting Gain and Unity-Gain Buffer:

- Connect the non-inverting pin (V_{IN+}) to the input with a wire that does not touch the PCB surface.
- Connect the guard ring to the inverting input pin (V_{IN-}). This biases the guard ring to the Common Mode input voltage.

2. For Inverting Gain and Trans-impedance Gain Amplifiers (convert current to voltage, such as photo detectors):

- Connect the guard ring to the non-inverting input pin (V_{IN+}). This biases the guard ring to the same reference voltage as the op-amp (e.g., $V_{DD}/2$ or ground).
- Connect the inverting pin (V_{IN-}) to the input with a wire that does not touch the PCB surface.

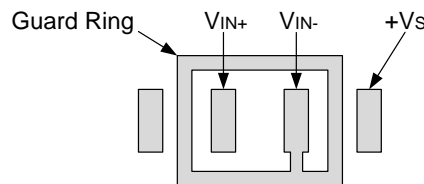

Figure 1

Ground Sensing and Rail to Rail Output

The TP2191(N) has excellent output drive capability, delivering over 10 mA of output drive current. The output stage is a rail-to-rail topology that is capable of swinging to within 5 mV of either rail. Since the inputs can go 300 mV beyond either rail, the op-amp can easily perform ‘true ground’ sensing.

The maximum output current is a function of total supply voltage. As the supply voltage to the amplifier increases, the output current capability also increases. Attention must be paid to keep the junction temperature of the IC below 150 °C when the output is in continuous short-circuit. The output of the amplifier has reverse-biased ESD diodes connected to each supply. The output should not be forced more than 0.5V beyond either supply, otherwise current will flow through these diodes.

ESD

The TP2191(N) has reverse-biased ESD protection diodes on all inputs and output. Input and out pins can not be biased more than 300 mV beyond either supply rail.

Shut-down

The TP2191N has SHDN pin that can shut down the amplifier to typical 3 nA supply current. The SHDN pin voltage needs to be within 0.5V of V_- for the amplifier to shut down. During shutdown, the output will be in high output resistance state, which is suitable for multiplexer applications. When left floating, the SHDN pin is internally pulled up to the positive supply and the amplifier remains enabled.

Driving Large Capacitive Load

The TP2191(N) op-amp is designed to drive large capacitive loads. Refer to Typical Performance Characteristics for “Phase Margin vs. Load Capacitance”. As always, larger load capacitance decreases overall phase margin in a feedback system where internal frequency compensation is utilized. As the load capacitance increases, the feedback loop’s phase margin decreases, and the closed-loop bandwidth is reduced. This produces gain peaking in the frequency response, with overshoot and ringing in output step response. The unity-gain buffer ($G = +1$ V/V) is the most sensitive to large capacitive loads.

When driving large capacitive loads with the TP2191(N) (e.g., > 200 pF when $G = +1$ V/V), a small series resistor at the output (R_{ISO} in Figure 2) improves the feedback loop’s phase margin and stability by making the output load resistive at higher frequencies.

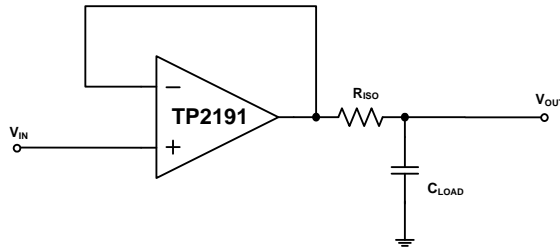

Figure 2

Power Supply Layout and Bypass

The TP2191(N) op-amp power supply pin (V_{DD} for single-supply) should have a local bypass capacitor (i.e., 0.01 μ F to 0.1 μ F) within 2 mm for good high frequency performance. It can also use a bulk capacitor (i.e., 1 μ F or larger) within 100 mm to provide large, slow currents. This bulk capacitor can be shared with other analog parts.

Ground layout improves performance by decreasing the amount of stray capacitance and noise at the OPA’s inputs and outputs. To decrease stray capacitance, minimize PC board lengths and resistor leads, and place external components as close to the op amps’ pins as possible.

Proper Board Layout

To ensure optimum performance at the PCB level, care must be taken in the design of the board layout. To avoid leakage currents, the surface of the board should be kept clean and free of moisture. Coating the surface creates a barrier to moisture accumulation and helps reduce parasitic resistance on the board.

Keeping supply traces short and properly bypassing the power supplies minimizes power supply disturbances due to output current variation, such as when driving an ac signal into a heavy load. Bypass capacitors should be connected as closely as possible to the device supply pins. Stray capacitances are a concern at the outputs and the inputs of the amplifier. It is recommended that signal traces be kept at least 5 mm from supply lines to minimize coupling.

A variation in temperature across the PCB can cause a mismatch in the Seebeck voltages at solder joints and other points where dissimilar metals are in contact, resulting in thermal voltage errors. To minimize these thermocouple effects, orient resistors so heat sources warm both ends equally. Input signal paths should contain matching numbers and types of components, where possible to match the number and type of thermocouple junctions. For example, dummy components such as zero value resistors can be used to match real resistors in the opposite input path. Matching components should be located in close proximity and should be oriented in the same manner. Ensure leads are of equal length so that thermal conduction is in equilibrium. Keep heat sources on the PCB as far away from amplifier input circuitry as is practical.

The use of a ground plane is highly recommended. A ground plane reduces EMI noise and also helps to maintain a constant temperature across the circuit board.

BATTERY CURRENT SENSING

The Common Mode Input voltage Range of TP2191(N) op-amp, which goes 0.3 V beyond both supply rails, supports their use in high-side and low-side battery current sensing applications. The low quiescent current (700 nA, typical) helps prolong battery life, and the rail-to-rail output supports detection of low currents.

TP2191/TP2191N

Small Size, Precision, 1.8V, 700nA Nanopower, RRIO Op-amps

The battery current (I_{DD}) through the $10\ \Omega$ resistor causes its top terminal to be more negative than the bottom terminal. This keeps the Common Mode Input voltage below V_{DD} , which is within its allowed range. The output of the OPA will also be below V_{DD} , within its Maximum Output Voltage Swing specification.

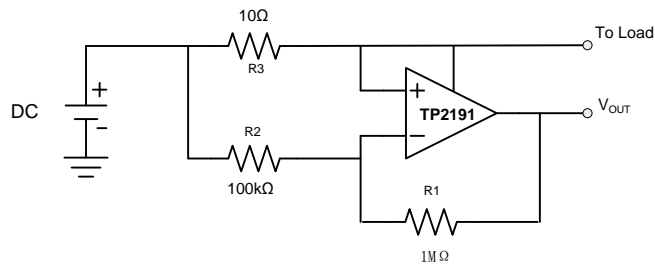

$$I_{DD} = \frac{V_{DD} - V_{OUT}}{\frac{R1}{R2} \cdot R3}$$

Figure 3

Buffered Chemical Sensor (pH) Probe

The TP2191(N) op-amp has input bias current in the pA range. This is ideal in buffering high impedance chemical sensors such as pH probe. As an example, the circuit in Figure 4 eliminates expensive low-leakage cables that that is required to connect pH probe to metering ICs such as ADC, AFE and/or MCU. A TP2191(N) op-amp and a lithium battery are housed in the probe assembly. A conventional low-cost coaxial cable can be used to carry OPA's output signal to subsequent ICs for pH reading.

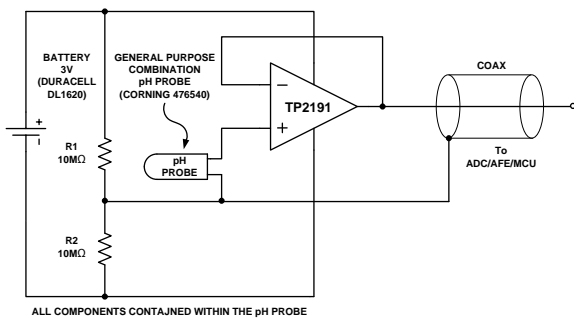

Figure 4: Buffer pH Probe

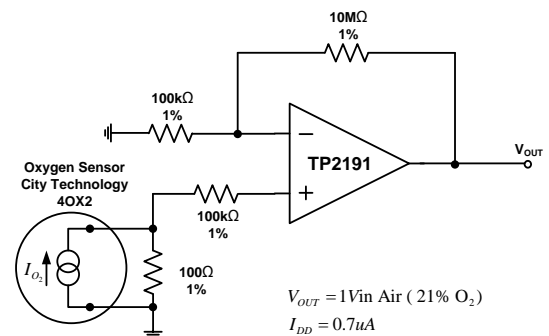

Figure 5

Portable Gas Sensor Amplifier

Gas sensors are used in many different industrial and medical applications. Gas sensors generate a current that is proportional to the percentage of a particular gas concentration sensed in an air sample. This output current flows through a load resistor and the resultant voltage drop is amplified. Depending on the sensed gas and sensitivity of the sensor, the output current can be in the range of tens of microamperes to a few milli-amperes. Gas sensor datasheets often specify a recommended load resistor value or a range of load resistors from which to choose.

There are two main applications for oxygen sensors – applications which sense oxygen when it is abundantly present (that is, in air or near an oxygen tank) and those which detect traces of oxygen in parts-per-million concentration. In medical applications, oxygen sensors are used when air quality or oxygen delivered to a patient needs to be monitored. In fresh air, the concentration of oxygen is 20.9% and air samples containing less than 18% oxygen are considered dangerous. In industrial applications, oxygen sensors are used to detect the absence of oxygen; for example, vacuum-packaging of food products.

The circuit in Figure 5 illustrates a typical implementation used to amplify the output of an oxygen detector. With the components shown in the figure, the circuit consumes less than 700 nA of supply current ensuring that small form-factor single- or button-cell batteries (exhibiting low mAh charge ratings) could last beyond the operating life of the oxygen sensor. The precision specifications of this amplifier, such as their low offset voltage, low V_{OS} TC, low input bias current, high CMRR, and high PSRR are other factors which make these amplifiers excellent choices for this application.

Package Outline Dimensions

SC-70-5 / SC-70-6 (SOT353 / SOT363)

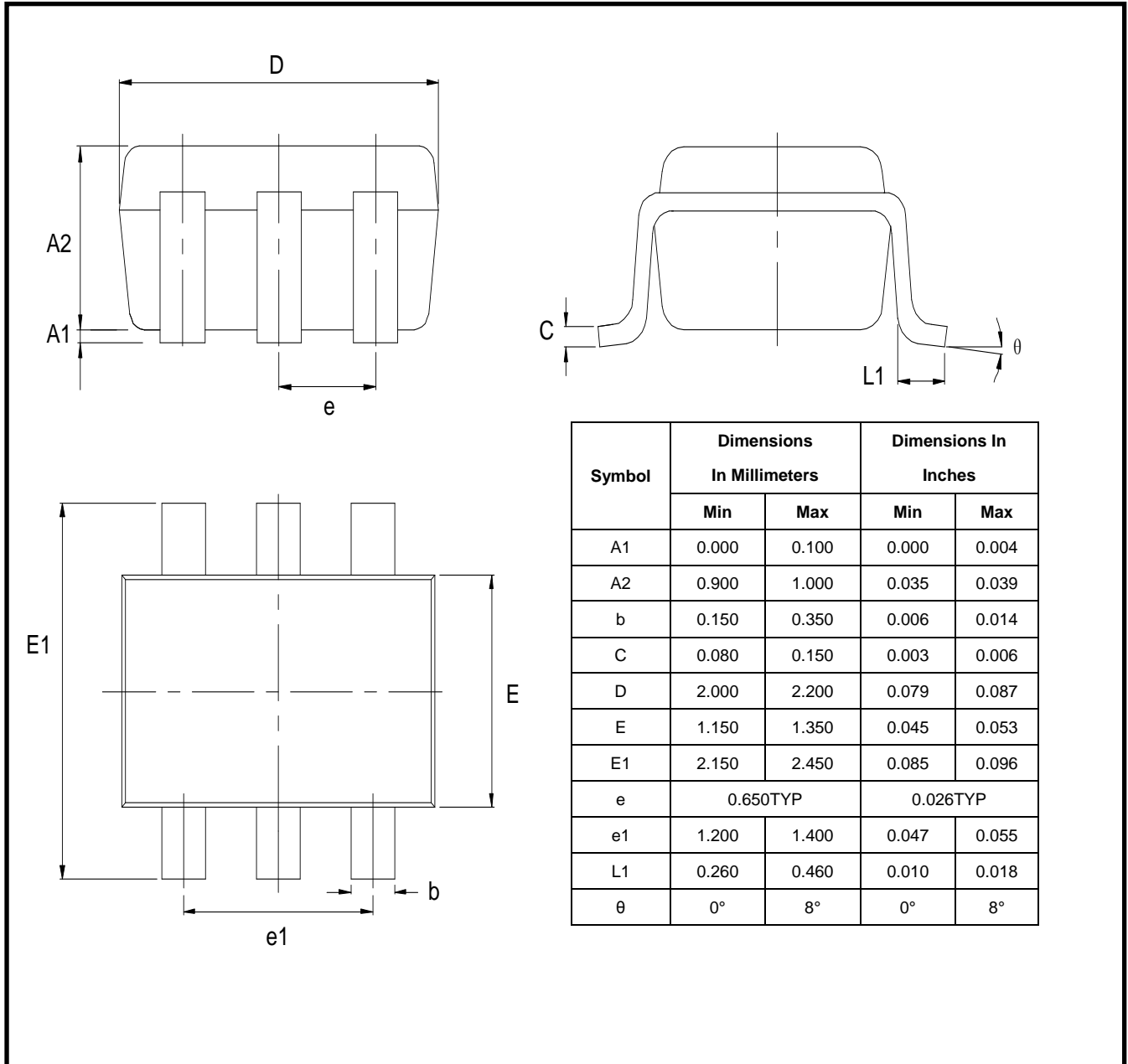

TP2191/TP2191N

Small Size, Precision, 1.8V, 700nA Nanopower, RRIO Op-amps

Package Outline Dimensions

SOT23-5 / SOT23-6

