

## Features

- Single FHD Video Filter Support HDCVI-1080p /1080i/720p, VGA/SVGA/XGA
- Optimized 6<sup>th</sup>-order Butterworth Video reconstruction filter:
  - FHD Channel: -3dB ≥ 72MHz
- Support Multiple Input Biasing:
  - Provide 80-mV Level-Shift when DC-Coupled
  - Transparent Input Clamping when AC-Coupled
  - Support External DC Biasing when AC-Coupled
- Very Low Quiescent Current: 11.5 mA(at 3.3V, Typical)
- 6dB Gain(2V/V), Rail TO Rail Output
- AC- or DC-Coupled Output Driving Dual Video Loads (75Ω)
- Wide Power Supply: +3.0V to +5.5V Single Supply
- Robust ESD Protection:
  - Robust 8kV – HBM and 2kV – CDM ESD Rating
- Green Product, SOT23-6 Package

## Applications

- Video Signal Amplification
- Set-Top Box Video Driver
- PVR、DVD Player Video Buffer
- Video Buffer for Portable or USB-Powered Video Devices
- HDTV

## Function Block

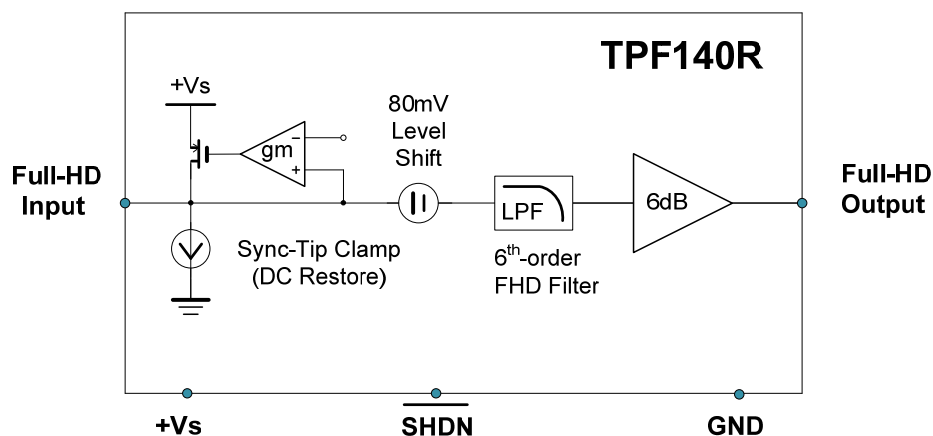

Figure 1.

## Description

TPF140R is a specially designed for consumer applications, high-performance, low-cost video reconstruction filter, it combine excellent video performance and low power consumption perfectly. It incorporates one Full high-definition (FHD) filter channels. The filter feature sixth-order Butterworth characteristics that are useful as digital-to-analog converter (DAC) reconstruction filters or as analog-to-digital converter (ADC) anti-aliasing filters. The FHD filters can be bypassed to support filters. The FHD filters can be bypassed to support 1080p60 video or up to quad extended graphics array (QXGA) RGB video.

As part of the TP140R flexibility, the input can be configured for ac- or dc-coupled inputs. The 84-mV output level shift allows for a full sync dynamic range at the output with 0-V input. The ac-coupled modes include a transparent sync-tip clamp option for Y', and G'B'R' signals. AC- coupled biasing for C'P'B/P'R channels can easily be achieved by adding an external resistor to VS+.

The TP140R rail-to-rail output stage with 6-dB gain allows for both ac and dc line driving. The ability to drive two lines, or 75-Ω loads, allows for maximum flexibility as a video line driver. The 11.5-mA total quiescent current at 3.3 V makes it an excellent choice for power-sensitive video applications.

TPF140R is available in SOT23-6 package. Its operation temperature range is from -40°C to +85°C.

## Related Resources

AN-1201: Application notes of TPF1xx

# TPF140R

## Full-HD Composite Video Filter Driver With Shutdown Function

### Order Information

Order Number	Operating Temperature Range	Package	Marking Information	Transport Media, Quantity
TPF140R-TR	-40 to 85°C	SOT23-6	F4R	Tape and Reel, 3000

### Pin configuration (Top View)

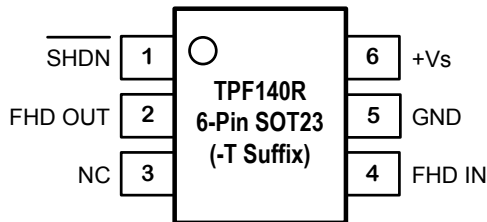

Figure 2.

Pin Name	Pin Function
FHD IN	Full-HD video input, LPF = 72 MHz
+V <sub>S</sub>	Positive Power Supply
GND	Ground
FHD OUT	Full-HD video output, LPF = 72 MHz
SHDN	High on this pin logic low to shut down the device. Range: Logic high enables the device and logic low shut down the device. <b>This pin defaults to logic high if left open.</b>

### Absolute Maximum Ratings\*

Parameters		Value	Units
Power Supply, V <sub>DD</sub> to GND		6.0	V
V <sub>IN</sub>	Input Voltage	V <sub>DD</sub> + 0.3V to GND - 0.3V	
I <sub>O</sub>	Output Current	65	mA
T <sub>J</sub>	Maximum Junction Temperature	150	°C
T <sub>A</sub>	Operating Temperature Range	-45 to 85	°C
T <sub>STG</sub>	Storage Temperature Range	-65 to 150	°C
TL	Lead Temperature (Soldering 10 sec)	300	°C
θ <sub>JA</sub>	6-Lead SOT23	170	°C/W
θ <sub>JC</sub>	6-Lead SOT23	130	°C/W

\* **Note:** Stresses beyond those listed under Absolute Maximum Ratings may cause permanent damage to the device. Exposure to any Absolute Maximum Rating condition for extended periods may affect device reliability and lifetime.

(1) This data was taken with the JEDEC low effective thermal conductivity test board.

(2) This data was taken with the JEDEC standard multilayer test boards.

### ESD, Electrostatic Discharge Protection

Symbol	Parameter	Condition	Minimum Level	Unit
HBM	Human Body Model ESD	MIL-STD-883H Method 3015.8	8	kV
CDM	Charged Device Model ESD	JEDEC-EIA/JESD22-C101E	2	kV

**TPF140R**  
**Full-HD Composite Video Filter Driver With Shutdown Function**

**Electrical Characteristics** All test condition is  $V_{DD} = 3.3V$ ,  $T_A = +25^\circ C$ ,  $R_L = 150\Omega$  to GND, unless otherwise noted.

SYMBOL	PARAMETER	CONDITIONS	MIN	TYP	MAX	UNITS
<b>Input Electrical Specifications</b>						
$V_{DD}$	Supply Voltage Range		3.0		5.5	V
$I_{CC}$	Quiescent current ( $I_Q$ )	$V_{DD} = 3.3V$ , $V_{IN} = 500mV$ , no load		11.5	14.27	mA
		$V_{DD} = 5.0V$ , $V_{IN} = 500mV$ , no load		15	18.53	mA
		$+V_S = 3.3V$ , $V_{IN} = 500mV$ , no load, disable		1		$\mu A$
		$+V_S = 3.3V$ , $V_{IN} = 500mV$ , no load, disable		1		$\mu A$
$V_{OLS}$	Output Level Shift Voltage	$V_{IN} = 0V$ , no load, input referred	53	80	124	mV
$I_{CLAMP-DOWN}$	Clamp Discharge Current	$V_{IN} = 300mV$ , measure current	1.1	2.0	5.3	$\mu A$
$I_{CLAMP-UP}$	Clamp Charge Current	$V_Y = -0.2V$	-1.5	-1.7		mA
$V_{CLAMP}$	Input Voltage Clamp	$I_Y = -100\mu A$	-40	0	+40	mV
AV	Voltage Gain	$V_{IN} = 0.5V, 1V$ or $2V$ $R_L = 150\Omega$ to GND	5.9	6.01	6.03	dB
PSRR	Power Supply Rejection Ratio	$\Delta V_{DD} = 3.3V$ to $3.6V$		61		dB
		$\Delta V_{DD} = 5.0V$ to $5.5V$ , 50Hz		67		dB
$V_{OL}$	Output Voltage Low Swing	$V_{IN} = -0.3V$ , $R_L = 75\Omega$		0.05	0.1	V
$V_{OH}$	Output Voltage High Swing	$V_{IN} = 3V$ , $R_L = 75\Omega$ to GND (dual load)	3	3.05	3.1	V
$I_{SC}$	Short-circuit current	$V_{IN} = 2V$ , $10\Omega$ , output to GND	65			mA
		$V_{IN} = 0.1V$ , output short to $V_{DD}$	65			mA
$V_{IH}$	Disable Threshold	$V_{DD} = 3.0V$ to $5.5V$	1.6			V
$V_{IL}$	Enable Threshold	$V_{DD} = 3.0V$ to $5.5V$			0.4	V
$t_{ON}$	Enable Time	$V_{IN} = 500mV$ , $V_{OUT}$ to 1%		1000		ns
$t_{OFF}$	Disable Time	$V_{IN} = 500mV$ , $V_{OUT}$ to 1%		1000		ns
<b>AC Electrical Specifications</b>						
$f_{-1dB}$	-1dB Bandwidth	$R_L = 150\Omega$	53.1	63.2	72.9	MHz
$f_{-3dB}$	-3dB Bandwidth	$R_L = 150\Omega$	63.7	71.5	80.1	MHz
$Att_{148MHz}$	Stop Band Attenuation	$f = 148MHz$	34	39		dB
SR	Slew Rate	2V output step, 80% to 20%		300		V/ $\mu s$
dG	Differential Gain	Video input range 1V		0.1	1	%
dP	Differential Phase	Video input range 1V		0.3	0.6	$^\circ$
THD	Total Harmonic Distortion	$f = 10MHz$ , $V_{OUT} = 1.4V_{PP}$		0.15		%
		$f = 22MHz$ , $V_{OUT} = 1.4V_{PP}$		0.6		%
D/DT	Group Delay Variation	$f = 100kHz$ to $27MHz$		2.5		ns
		$f = 100kHz$ to $60MHz$		6.0		ns
$t_{PD}$	Propagation Delay	Maximum delay from input to output: (100kHz to 60MHz)		11.0	18.0	ns
$X_{TALK}$	Channel Crosstalk	$f = 1MHz$ , $V_{OUT} = 1.4V_{PP}$	-68	-74		dB
SNR	Signal-to-Noise Ration	$f = 100kHz$ to $60MHz$		64		dB
$R_{OUT\_AC}$	Output Impedance	$f = 10MHz$		0.5		$\Omega$

**Typical Performance Characteristics** All test condition is  $V_{DD} = 3.3V$ ,  $T_A = +25^\circ C$ ,  $R_L = 150\Omega$  to GND, unless otherwise noted.

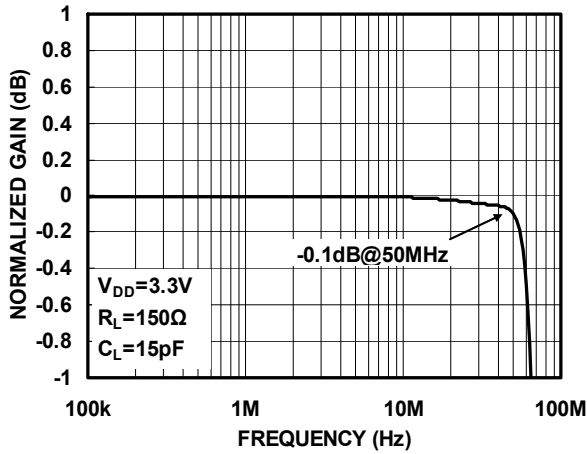

Figure3. Small-Scale Frequency Response

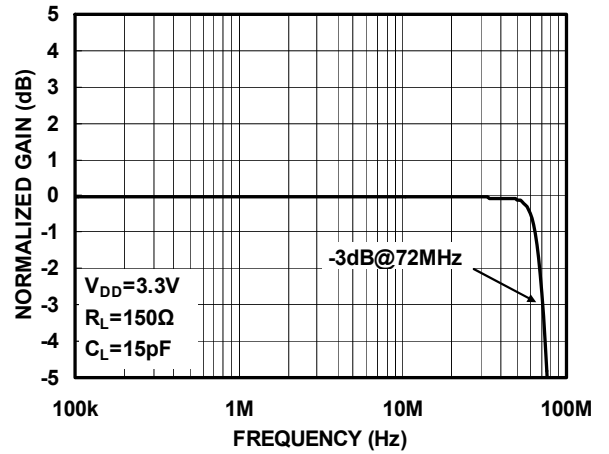

Figure4. Large-Scale Frequency Response

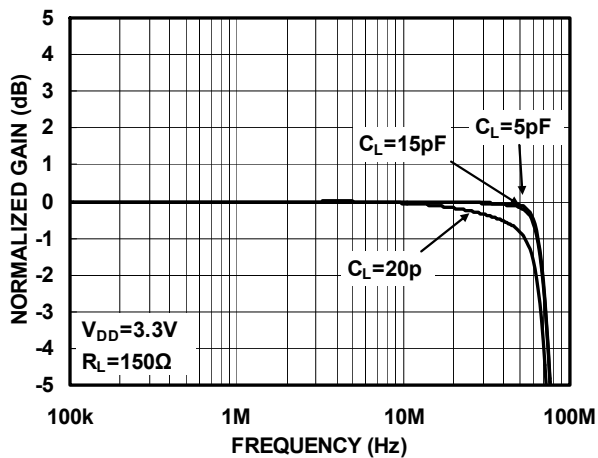

Figure5. Gain Vs. Frequency With  $C_{LOAD}$

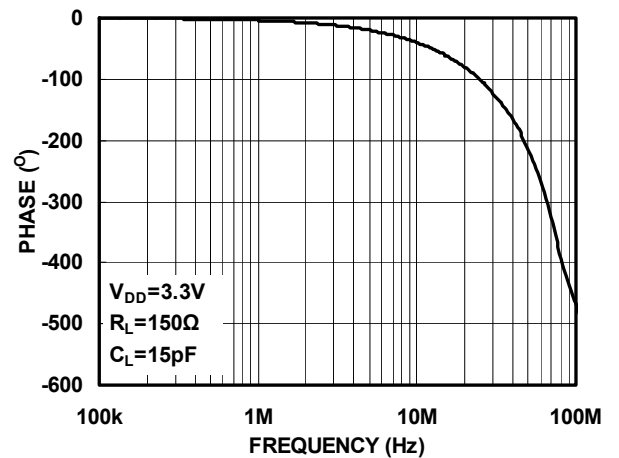

Figure6. Gain Vs. Frequency

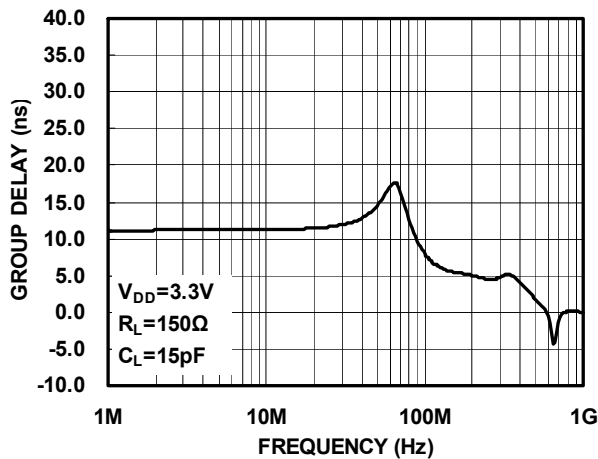

Figure7. Group Delay vs Frequency

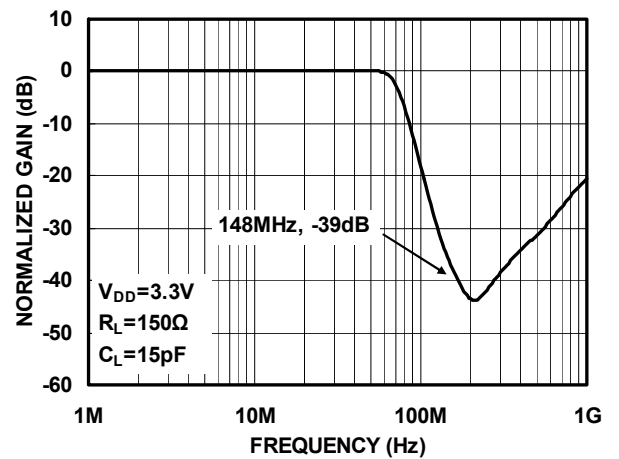

Figure8. Stop Band Attenuation

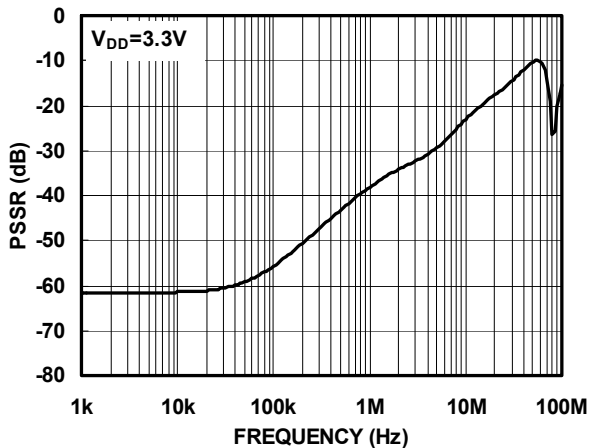

Figure9. PSRR Vs. Frequency

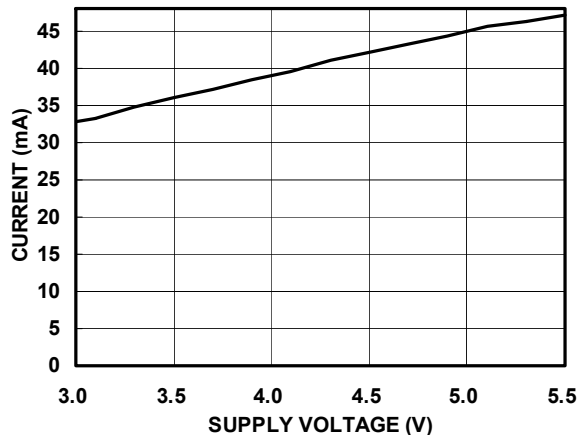

Figure10. Current Vs. Supply Voltage

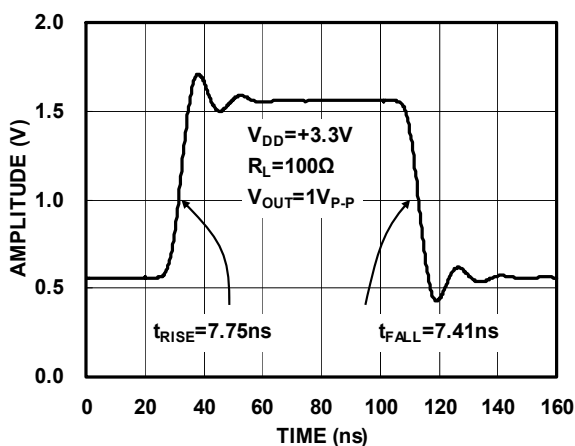

Figure11. Large-Signal Pulse Response Vs. Time

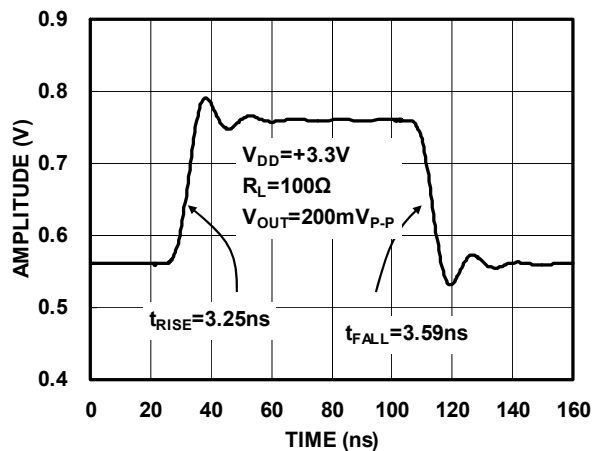

Figure12. Small-Signal Pulse Response Vs. Time

## Application Information

The TPF140R is targeted for systems that require one full high-definition (FHD) video outputs. Although it can be used for numerous other applications, the needs and requirements of the video signal are the most important design parameters of the TPF140R. The TPF140R incorporates many features not typically found in integrated video parts while consuming very low power.

### Internal Sync Clamp

The typical embedded video DAC operates from a ground referenced single supply. This becomes an issue because the lower level of the sync pulse output may be at a 0V reference level to some positive level. The problem is presenting a 0V input to most single supply driven amplifiers will saturate the output stage of the amplifier resulting in a clipped sync tip and degrading the video image. A larger positive reference may offset the input above its positive range.

The TPF140R features an internal sync clamp and offset function to level shift the entire video signal to the best level before it reaches the input of the amplifier stage. These features are also helpful to avoid saturation of the output stage of the amplifier by setting the signal closer to the best voltage range.

The simplified block diagram of the TPF140R in Figure-1. The AC coupled video sync signal is pulled negative by a current source at the input of the comparator amplifier. When the sync tip goes below the comparator threshold the output comparator is driven negative, The PMOS device turns on clamping sync tip to near ground level. The network triggers on the sync tip of video signal.

### Droop Voltage and DC Restoration

Selection of the input AC-coupling capacitance is based on the system requirements. A typical sync tip width of a 64µs NTSC line is 4µs during which clamp circuit restores its DC level. In the remaining 60µs period, the voltage droops because of a small constant 2.0µA sinking current. If the AC-coupling capacitance is 0.1µF, the maximum droop voltage is

about 1mV which is restored by the clamp circuit. The maximum pull-up current of the clamp circuit is 1.7mA. For a 4µs sync tip width and 0.1µF capacitor, the maximum restoration voltage is about 80mV.

The line droop voltage will increase if a smaller AC-coupling capacitance is used. For the same reason, if larger capacitance is used the line droop voltage will decrease. Table 1 is droop voltage and maximum restoration voltage of the clamp for typical capacitance.

**Table 1. Maximum restoration voltage and droop voltage of Y signals for different capacitance**

CAP VALUE (nF)	DROOP IN 60µs (mV)	CHARGE IN 4µs (mV)
100	1.2	68
1,000	0.12	6.8

### Low Pass Filter--Sallen Key

The Sallen Key is a classic low pass configuration. This provides a very stable low pass function, and in the case of the TPF140R, the six-pole roll-off at around 72MHz. The six-pole function is accomplished with an RC low pass network placed in series with and before the Sallen Key.

### Output Couple

TPF140R output could support both “AC Couple” and “DC Couple”, if use “AC Couple”, this capacitor is typically between 220-µF and 1000-µF, although 470-µF is common. This value of this capacitor must be this large to minimize the line tilt (droop) and/or field tilt associated with ac-coupling as described previously in this document.

The TPF140R internal sync clamp makes it possible to DC couple the output to a video load, eliminating the need for any AC coupling capacitors, thereby saving board space and additional expense for capacitors. This makes the TPF140R extremely attractive for portable video applications. Additionally, this solution completely eliminates the issue of field tilt in the lower frequency. The trade off is greater demand of supply current. Typical load current for AC coupled is around 1mA, compared to typical 6.6mA

used when DC coupling.

## Output Drive Capability and Power Dissipation

With the high output drive capability of the TPF140R, it is possible to exceed the +125°C absolute maximum junction temperature under certain load current conditions. Therefore, it is important to calculate the maximum junction temperature for an application to determine if load conditions or package types need to be modified to assure operation of the amplifier in a safe operating area. The maximum power dissipation allowed in a package is determined according to Equation:

$$PD_{MAX} = \frac{T_{JMAX} - T_{AMAX}}{\theta_{JA}}$$

Where:

$T_{JMAX}$  = Maximum junction temperature

$T_{AMAX}$  = Maximum ambient temperature

$\theta_{JA}$  = Thermal resistance of the package

The maximum power dissipation actually produced by an IC is the total quiescent supply current times the total power supply voltage, plus the power in the IC due to the load, or: for sourcing:

$$PD_{MAX} = V_s \times I_{SMAX} + (V_s - V_{OUT}) \times \frac{V_{OUT}}{R_L}$$

Where:

$V_s$  = Supply voltage

$I_{SMAX}$  = Maximum quiescent supply current

$V_{OUT}$  = Maximum output voltage of the application

$R_{LOAD}$  = Load resistance tied to ground

By setting the two PD<sub>MAX</sub> equations equal to each other, we can solve the output current and R<sub>LOAD</sub> to avoid the device overheat.

## Power Supply Bypassing Printed Circuit Board Layout

As with any modern operational amplifier, a good printed circuit board layout is necessary for optimum performance. Lead lengths should be as short as possible. The power supply pin must be well bypassed to reduce the risk of oscillation. For normal single supply operation, a single 4.7µF tantalum capacitor in parallel with a 0.1µF ceramic capacitor from VS+ to GND will suffice.

## VIDEO FILTER DRIVER SELECTION GUIDE

P/N	Product Description	Channel	-3dB Bandwidth	Package
TPF110 /TPF110L	Low power, enable function and SAG correction, 1 channel 6 <sup>th</sup> order 9MHz	1-SD	9MHz	SC70-5 SOT23-6
TPF113	Low power 3 channel, 6th-order 9MHz SD video filter	3-SD	9MHz	SO-8
TPF114	Low power 4 channel, 6th-order 9MHz SD video filter	4-SD	9MHz	MSOP-10 TSSOP-14
TPF116	Low power 4 channel, 6th-order 9MHz SD video filter for CVBS, SVIDEO	6-SD	9MHz	TSSOP-14
TPF123	3 channel 6th-order 13.5MHz, 960H/720H-CVBS video filter or Y'Pb'Pr 480P/576P video filter	3-ED	13.5MHz	SO-8
TPF133	Low power 3 channel, 6th-order 36MHz HD video filter	3-HD	36MHz	SO-8
TPF134	Low power 3 channel, 6th-order 36MHz HD video filter and 1 channel	1-SD& 3-SD	9MHz 36MHz	MSOP-10 TSSOP-14

## TPF140R

### Full-HD Composite Video Filter Driver With Shutdown Function

---

	SD video filter			
TPF136	Low power 3 channel, 6th-order 36MHz HD video filter and 3 channel SD video filter	3-SD& 3-HD	9MHz 36MHz	TSSOP-20
TPF143	Low power 3 channel, 6th-order 72MHz Full HD video filter	3-FHD	72MHz	SO-8
TPF144	Low power 3 channel, 6th-order 72MHz Full HD video filter and 1 channel SD video filter	1-SD& 3-FHD	9MHz 72MHz	MSOP-10 TSSOP-14
TPF146	Low power 3 channel, 6th-order 72MHz Full HD video filter and 3 channel SD video filter	3-SD& 3-FHD	9MHz 72MHz	TSSOP-20
TPF153	Low power 3 channel, 6th-order 220MHz Full HD video filter	3-CH	220MHz	SO-8

---



## Package Outline Dimensions

SOT23-6

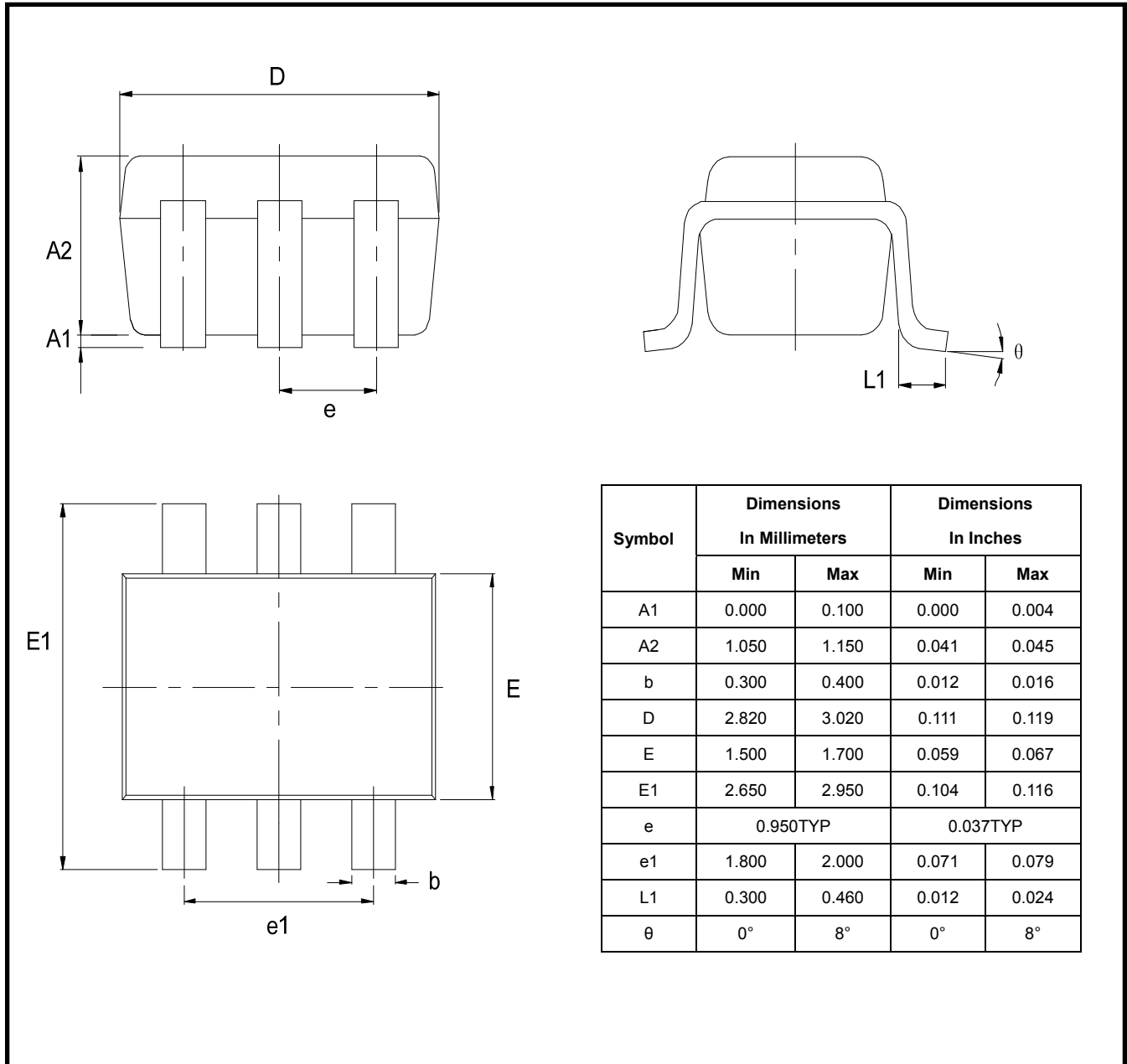

**IMPORTANT NOTICE**

"PRELIMINARY" PRODUCT INFORMATION DESCRIBES PRODUCTS THAT ARE IN PRODUCTION, BUT FOR WHICH FULL CHARACTERIZATION DATA IS NOT YET AVAILABLE.

3PEAKIC MICROELECTRONICS CO. LTD BELIEVES THAT THE INFORMATION CONTAINED IN THIS DOCUMENT IS ACCURATE AND RELIABLE. HOWEVER, THE INFORMATION IS SUBJECT TO CHANGE WITHOUT NOTICE AND IS PROVIDED "AS IS" WITHOUT WARRANTY OF ANY KIND (EXPRESS OR IMPLIED). CUSTOMERS ARE ADVISED TO OBTAIN THE LATEST VERSION OF RELEVANT INFORMATION TO VERIFY, BEFORE PLACING ORDERS, THAT INFORMATION BEING RELIED ON IS CURRENT AND COMPLETE. ALL PRODUCTS ARE SOLD SUBJECT TO THE TERMS AND CONDITIONS OF SALE SUPPLIED AT THE TIME OF ORDER ACKNOWLEDGMENT, INCLUDING THOSE PERTAINING TO WARRANTY, INDEMNIFICATION, AND LIMITATION OF LIABILITY. NO RESPONSIBILITY IS ASSUMED BY 3PEAKIC MICROELECTRONICS CO. LTD FOR THE USE OF THIS INFORMATION, INCLUDING USE OF THIS INFORMATION AS THE BASIS FOR MANUFACTURE OR SALE OF ANY ITEMS, OR FOR INFRINGEMENT OF PATENTS OR OTHER RIGHTS OF THIRD PARTIES. THIS DOCUMENT IS THE PROPERTY OF 3PEAKIC MICROELECTRONICS CO. LTD AND BY FURNISHING THIS INFORMATION, 3PEAKIC MICROELECTRONICS CO. LTD GRANTS NO LICENSE, EXPRESS OR IMPLIED UNDER ANY PATENTS, MASK WORK RIGHTS, COPYRIGHTS, TRADEMARKS, TRADE SECRETS OR OTHER INTELLECTUAL PROPERTY RIGHTS. 3PEAKIC MICROELECTRONICS CO. LTD OWNS THE COPYRIGHTS ASSOCIATED WITH THE INFORMATION CONTAINED HEREIN AND GIVES CONSENT FOR COPIES TO BE MADE OF THE INFORMATION ONLY FOR USE WITHIN YOUR ORGANIZATION WITH RESPECT TO 3PEAKIC MICROELECTRONICS CO. LTD INTEGRATED CIRCUITS OR OTHER PRODUCTS OF 3PEAKIC MICROELECTRONICS CO. LTD. THIS CONSENT DOES NOT EXTEND TO OTHER COPYING SUCH AS COPYING FOR GENERAL DISTRIBUTION, ADVERTISING OR PROMOTIONAL PURPOSES, OR FOR CREATING ANY WORK FOR RESALE.

CERTAIN APPLICATIONS USING SEMICONDUCTOR PRODUCTS MAY INVOLVE POTENTIAL RISKS OF DEATH, PERSONAL INJURY, OR SEVERE PROPERTY OR ENVIRONMENTAL DAMAGE ("CRITICAL APPLICATIONS"). 3PEAKIC MICROELECTRONICS CO. LTD PRODUCTS ARE NOT DESIGNED, AUTHORIZED OR WARRANTED FOR USE IN AIRCRAFT SYSTEMS, MILITARY APPLICATIONS, PRODUCTS SURGICALLY IMPLANTED INTO THE BODY, AUTOMOTIVE SAFETY OR SECURITY DEVICES, LIFE SUPPORT PRODUCTS OR OTHER CRITICAL APPLICATIONS. INCLUSION OF 3PEAKIC MICROELECTRONICS CO. LTD PRODUCTS IN SUCH APPLICATIONS IS UNDERSTOOD TO BE FULLY AT THE CUSTOMER'S RISK AND INCLUSION DISCLAIMS AND MAKES NO WARRANTY, EXPRESS, STATUTORY OR IMPLIED, INCLUDING THE IMPLIED WARRANTIES OF MERCHANTABILITY AND FITNESS FOR PARTICULAR PURPOSE, WITH REGARD TO ANY DISCLAIMS PRODUCT THAT IS USED IN SUCH A MANNER. IF THE CUSTOMER OR CUSTOMER'S CUSTOMER USES OR PERMITS THE USE OF 3PEAKIC MICROELECTRONICS CO. LTD PRODUCTS IN CRITICAL APPLICATIONS, CUSTOMER AGREES, BY SUCH USE, TO FULLY INDEMNIFY 3PEAKIC MICROELECTRONICS CO. LTD, ITS OFFICERS, DIRECTORS, EMPLOYEES, DISTRIBUTORS AND OTHER AGENTS FROM ANY AND ALL LIABILITY, INCLUDING ATTORNEYS' FEES AND COSTS, THAT MAY RESULT FROM OR ARISE IN CONNECTION WITH THESE USES.

THE LOGO DESIGNS OF 3PEAKIC MICROELECTRONICS CO. LTD ARE TRADEMARKS OF DESIGNS. ALL OTHER BRAND AND PRODUCT NAMES IN THIS DOCUMENT MAY BE TRADEMARKS OR SERVICE MARKS OF THEIR RESPECTIVE OWNERS.

**Contact information:**

**USA:** 635 W. Alma School Road, Suite102

Chandler, USA.

AZ 85234

**Shanghai-China:** Room 401-407 No.1278 Keyuan Road,

Zhangjiang High-tech Park, Pudong New District,

Shanghai, China

Zip Code: 201203

**Suzhou-China:** Suite 304, Building B2, Creative Industrial Park,

No.328 Xinghu Street, Industrial Park,

Suzhou, Jiangsu Province, China

Zip Code: 215123